

Innovation for the next generation



# ML4070-QSFP

4-Lane | 8.5-15 & 21-30 Gbps/lane |  
QSFP28 Transceiver Test Set |

VSR Trace length Margining | Power Supply  
Margining | PS Noise Margining | Bit Rate  
Margining | Bathtub Curve Measurement | Eye  
Contour Measurement | Receiver Sensitivity |

## Summary

MultiLane's ML4070-QSFP is a transceiver margin test fixture for QSFP+/QSFP28 transceiver testing. This set has numerous features yet is designed specially for the speedy production testing of Go/No Go applications.

# ML4070-QSFP

## QSFP28 Transceiver Test Set

### Introduction

The ML4070-QSFP is a state-of-the-art transceiver test set specifically designed for quick production testing of Go/No Go applications. It features Pulse Pattern Generators and Error Detectors as well as QSFP host control circuitry with power supply noise injection capability. The ML4070 displays 3 QSFP ports for 0 dB and 9 dB trace loss as well as for loopback. A full set of APIs and a production GUI enable quick one-button measurements and automatic report generation.

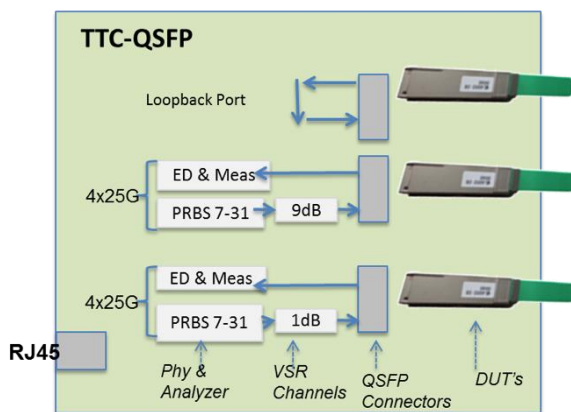

### Key Features

- High Operation 0 to 70°C
- DUT Voltage Margining 3.1 to 3.6V
- DUT Power Supply Noise Margin
- DUT Current Draw Measurement
- DUT State Machine Interface and MSA configuration
- BER graphs as a function of (PS voltage, PS noise, Bit Rate  $\pm 100$ ppm)
- MSA Compatible QSFP MCB
- Eye Contour measurements
- Pre-emphasis tolerance Testing

- GUI and API control
- Sample aperture jitter below 60 fs

### S21 & S11 Characteristics of the 9dB Port

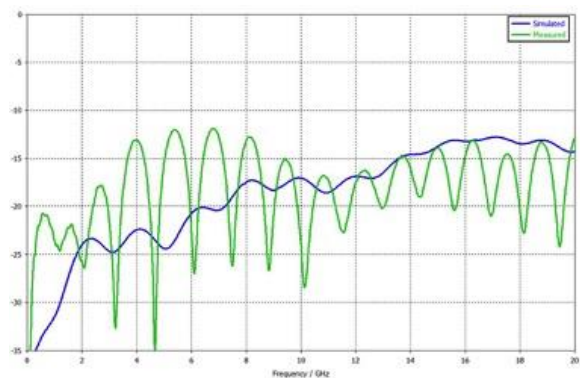
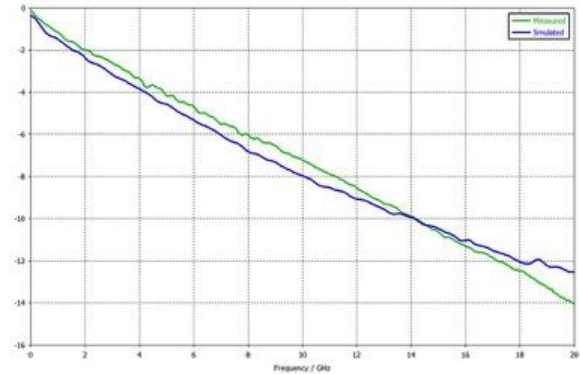

### ML4070 BERT GUI

- Tests four-channel BER test at the same time
- Supports BER curve
- Provides multiple and single layouts of bathtub and eye contour

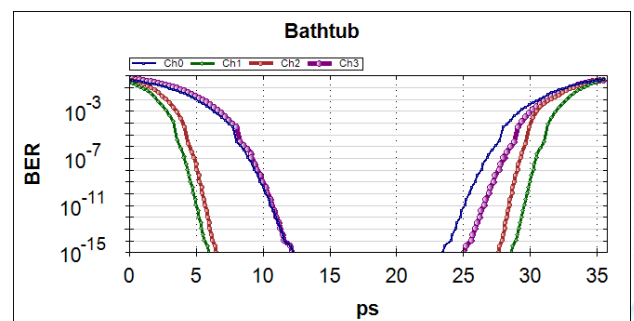

Figure 1: Bathtub curve

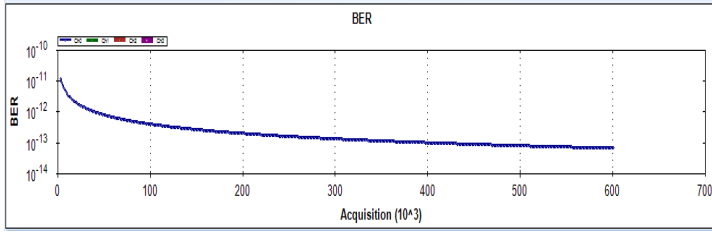

Figure 2: BER curve for one channel with 1 error inserted at the MSB and LSB respectively

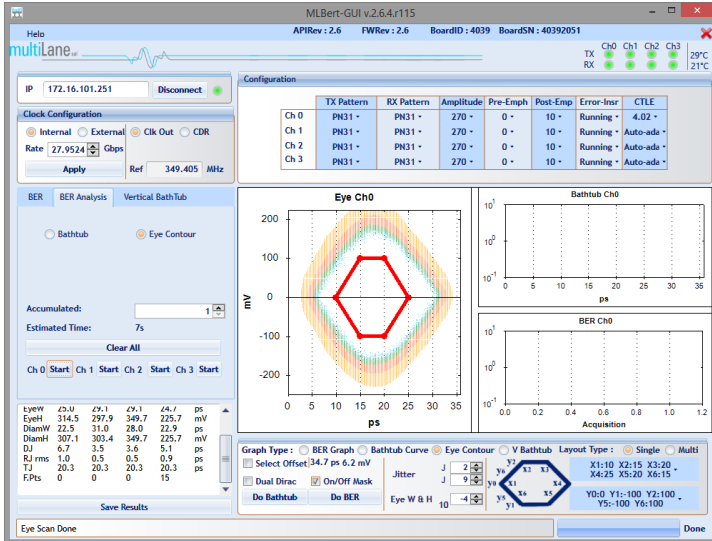

Figure 3: Single layout of Contour for one channel

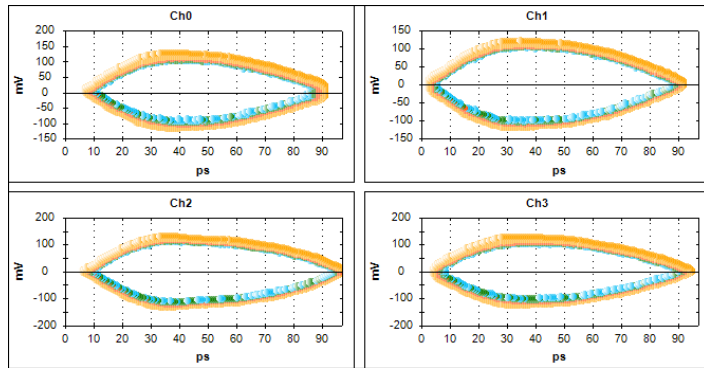

Figure 4: Multiple layouts of eye contour for four channels

## Electrical Specifications

Parameter	ML4070
Bit Rate	8.5-15 & 21-30Gbps
Pattern	PRBS 7, 9, 15, 23, 31, and User Defined Pattern 16 bits@10G & 40 bits@25G
TX Amplitude Differential	200-800mV
TX Amplitude Adjustment	200 mV/step
Pre-Emphasis	6dB
Pre-Emphasis Resolution	20 steps
Equalizing Filter Spacing	-
Total Jitter pk-pk @10G	10 ps (typical)
Total Jitter pk-pk @25G	12 ps (typical)
Rise/Fall Time (20–80%) @25G	17 ps
Sinusoidal Phase Modulation	-
Sinusoidal Jitter Frequency	-
Random Jitter in Phase Modulation	-
Output Return Loss up to 10GHz	< -15 dB
Output Return Loss (16-25GHz)	< -8dB
TX Skew Control Range	-
Lane to Lane Skew Resolution	-
Error Detector Input Amplitude	110-1050 mVpp @11G, 1200 mVpp @25G
Error Detector Maximum Input	1200mV Diff
Error Detector Input Sensitivity	30 mVpp @ 10.3125G / 50 mVpp @ 28G
Phase Scan Resolution	7 bits
Vertical Scan Resolution	8 bits
Input CTLE Dynamic Range	10dB
Reference Clock Output	Rate/32 for 8.5-15G and Rate/80 for 21-30G
Reference Clock Output Amplitude	550-850 mVpp
Reference Clock Input	Rate/32 for 8.5-15G and Rate/80 for 21-30G
Reference Clock Input Amplitude	300-1900 mVpp
Clock Data Recovery	Rate/N (user selectable from 8 and 16)
Power Requirement	12 V dc, 40 W max

## Mechanical Dimensions

The ML4070-QSFP is a benchtop instrument that fits in a 19-inch 2U rack. Two ML4070-QSFPs arranged side by side take up one 2U slot in your rack. MultiLane also supplies the needed brackets.



## Ordering Information

Option	Description
ML4070-QSFP	QSFP28 Compliance Tester

Please contact us at [sales@multilaneinc.com](mailto:sales@multilaneinc.com).